

The Ultimate

EVOLUTION Aluminium Bi-Folding Door



Cutting-edge innovation with Ultra slim sightlines



End-user appeal and high margin 'engineered-in'

The Ultimate Evolution redefines bi-folding door design with a 'hardware-first approach'.

It's built around the latest innovation in hardware design, which ensures not only effortless operation and reliability – but also makes installation far simpler.

With ultra slim sightlines, a wide choice of colours, multiple threshold and bead to accommodate double or triple glazed units. The Ultimate Evolution is an aluminium bi-folding door that delivers on end user appeal – but also through-life performance.

Many other manufacturers build their bifolds on benches. This can often result in the frame or doors not being fully square and this will cause many issues when installing. Every bifold we manufacture is built on our rigs, whether it has two doors or even up to seven! Every bifold is built from the ground up and are as square as they can be. Making them easy to install and operate as intended.





Exacting detail and flexibility in design



BS6375 Weather Tested

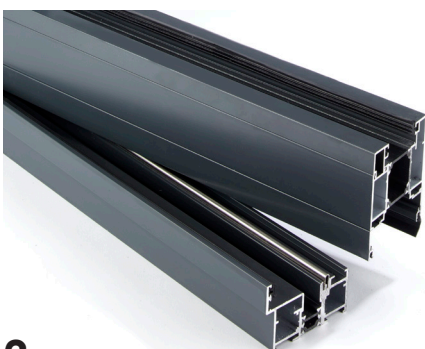

Structural strength

The Ultimate Evolution taps into the inherent strength of aluminium to deliver slim sightlines but also incredible design flexibility, accommodating larger individual panels, and multiple configurations to span openings of up to 8400mm*.

Advanced performance

A 30mm polyamide thermal break delivers impressive U-values, while the Ultimate Evolution is also fully BS6375 Weather Tested.

Configurations

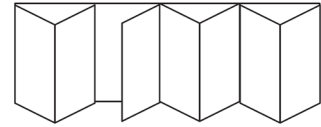

3-2-1

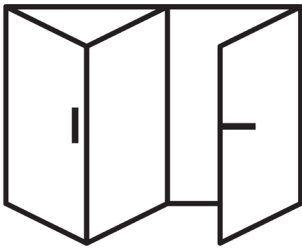

3 - The total number of sashes

2 - The number of sashes opening to the left

1 - The number of sashes opening to the right

With inward and outward opening options, the Ultimate Evolution offers exceptional design flexibility with 33 different configurations and up to a maximum seven individual panels.

Externally Viewed

Reverse configurations also available, eg. 3-3-0 and 3-0-3

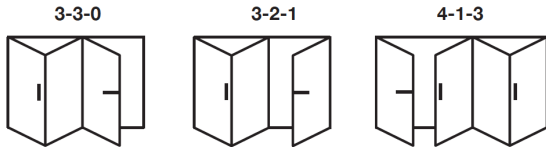

— Internal and External Master Door Handle Position
Lever/Lever with 3* cylinder and key

| Shootbolt Handle Position
Internal handle/s without cylinder and key

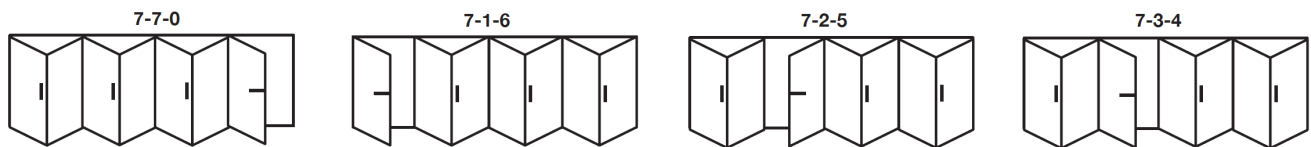
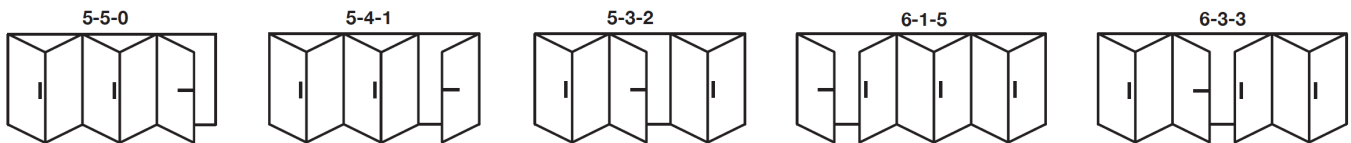

Non Document Q or PAS24 Compliant

Reverse configurations also available, eg. 2-0-2 and 2-2-0

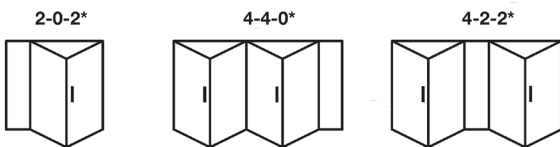

* No external access as standard for these configurations
Handles displayed are internally positioned

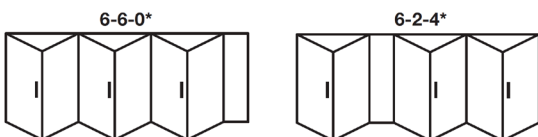

Internal locking with cylinder & Internal / External locking with cylinder options available - These options DO NOT comply with Document Q / PAS24

Standard Threshold, Cill and Sightlines

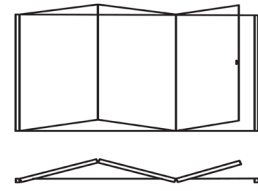

Standard Weather Rated Threshold

The standard threshold is 55mm in height and is weather rated. This threshold is suitable for a bifold positioned with one side external of a property.

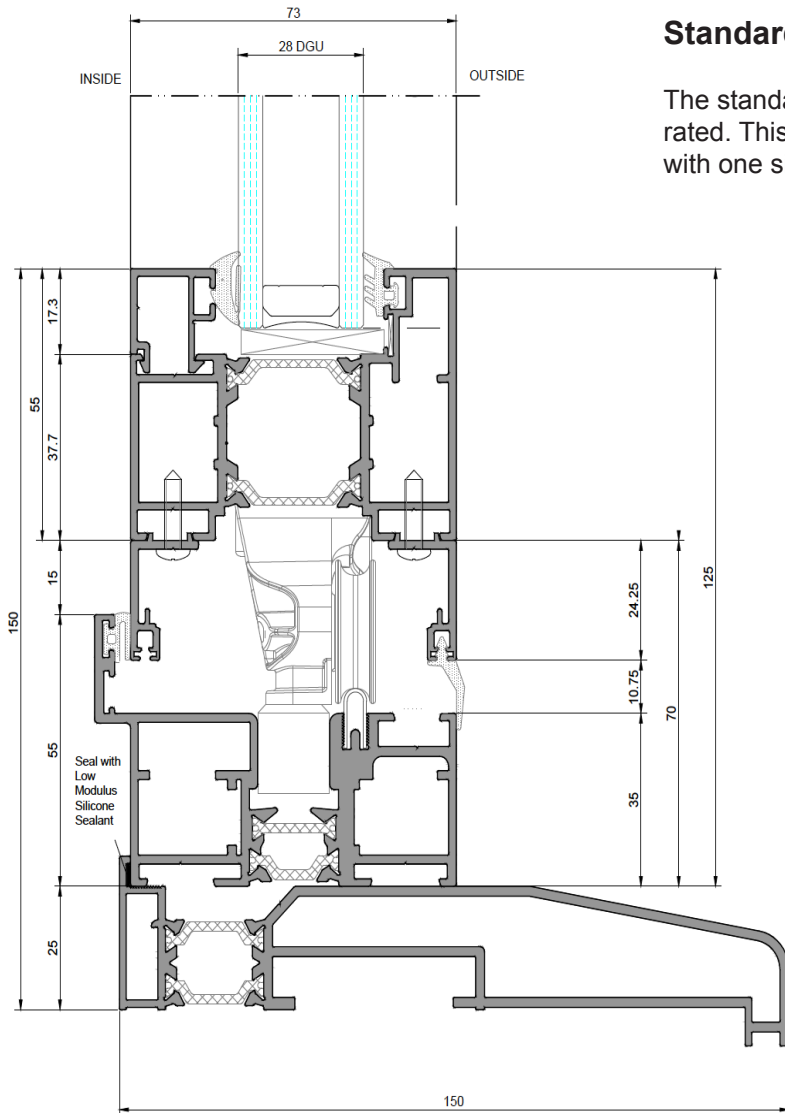

Intermediate lock with hinges and shootbolt

Sightlines of 133mm

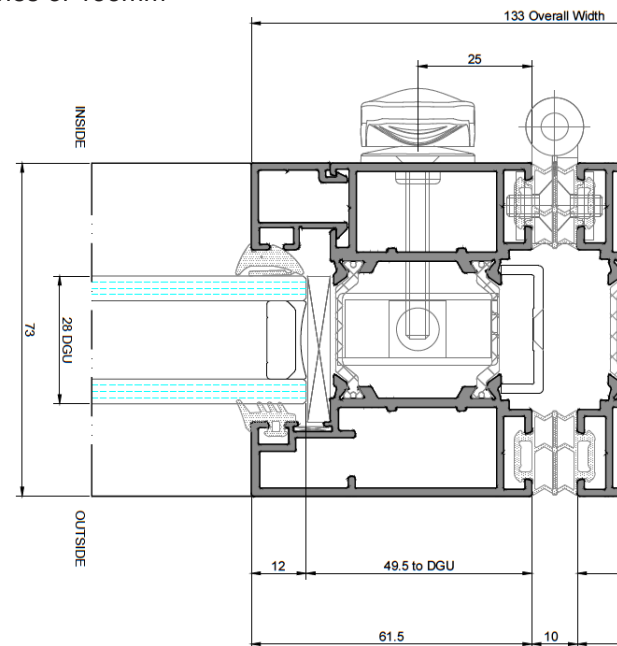

Cill options

A cill is optional. All cill options are 25mm in height. Cills are available in the following depth sizes:

- 90mm
- 150mm
- 190mm

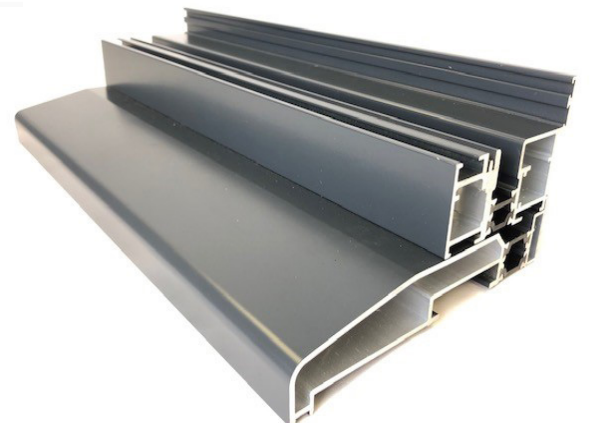

Low Threshold, Rebate and Ramps

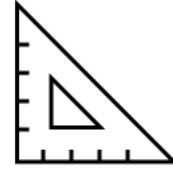

Low Threshold

The Low 20mm threshold is NOT weather rated and is designed for internal use only. For example; if the bifold is positioned between a room and a conservatory.

The Low threshold and components are only available in silver.

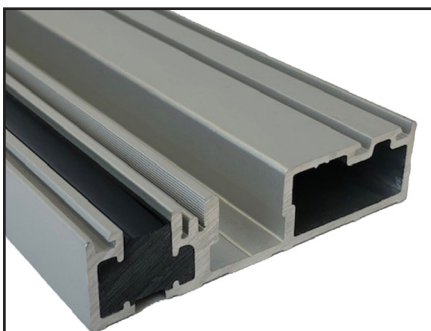
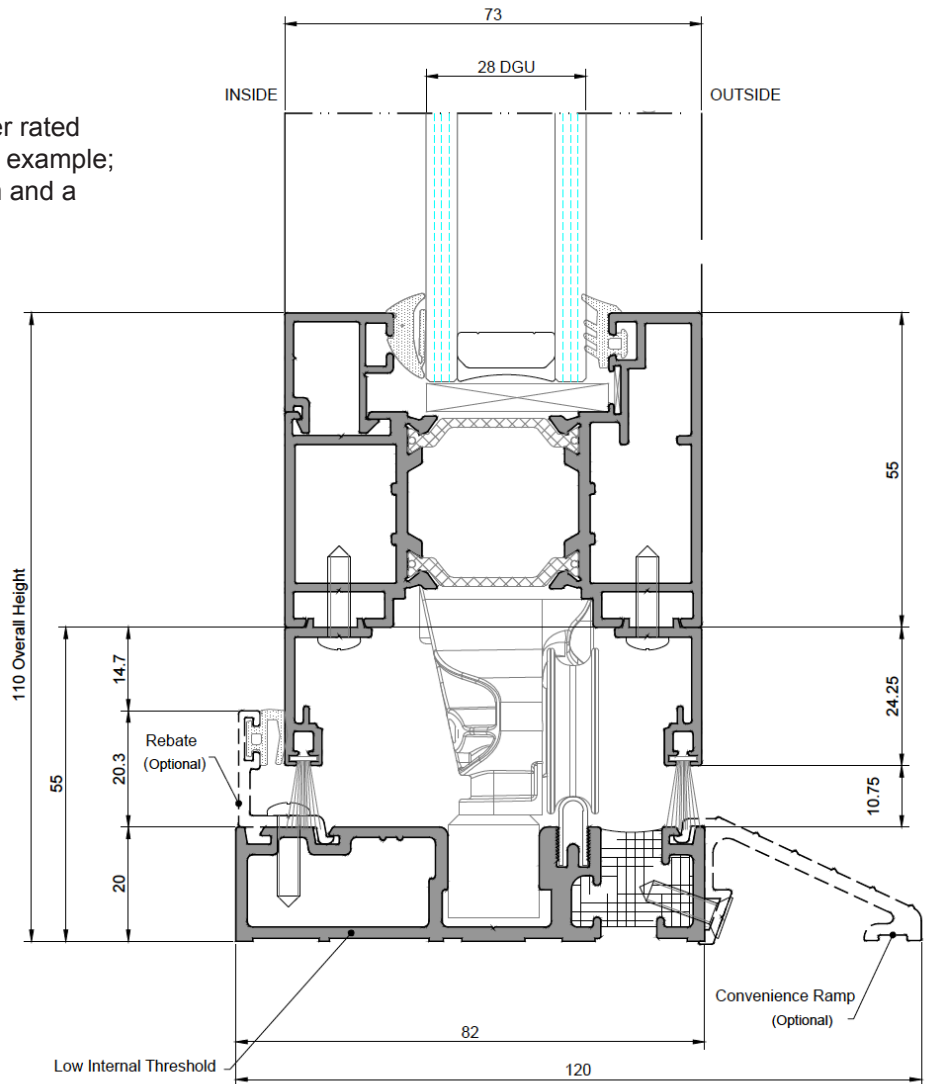
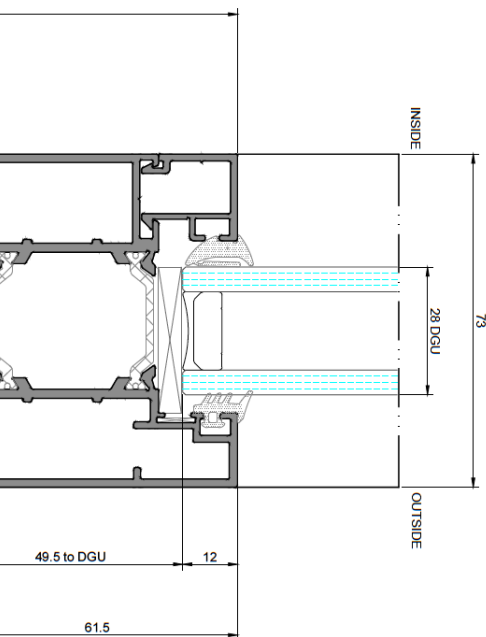

Internal Low
Threshold



Internal Low Threshold
with Rebate



Internal Low Threshold
with Rebate & Ramp





Finish options



Standard profile colours

The Ultimate Evolution is available as standard in White, Anthracite Grey and Anthracite Grey on White.

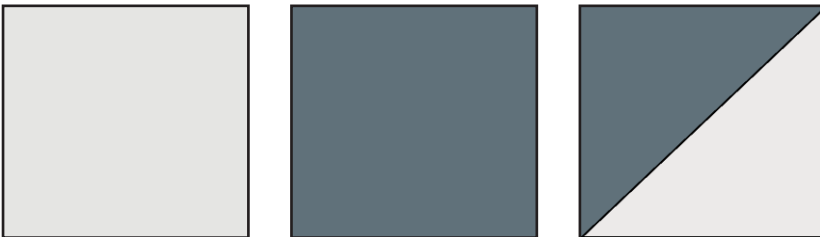

Special Colours

We also offer over 200 RAL colours and combination of colours. Special colours incur an additional charge and lead time.

Polyester powder coated to BS/EN12206-1:2004, minimum finish thicknesses are 40 microns.

Renolit Foil

Golden Oak or Rosewood Renolit Foil external on White internal.

A fantastic complement for the homeowner who desires a quality aluminium bi-fold that will match their existing PVC windows.

Currently available in the following configurations: 3-0-3, 3-3-0, 5-0-5, 5-5-0, 7-0-7 and 7-7-0 with or without a 150mm Cill and Black Hardware.

All above finishes are guaranteed for 10-years.

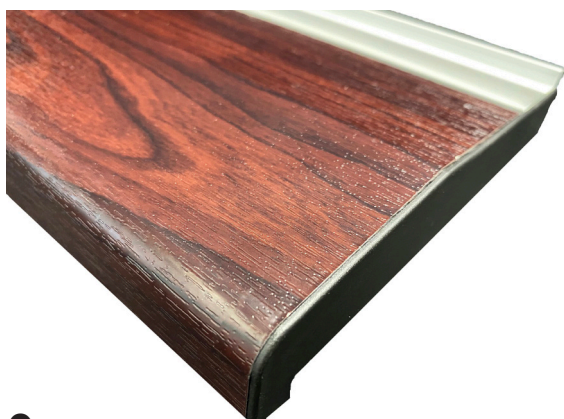

Hardware options



Door handle options

Lever/Lever handles with 3* Cylinder



Black



White



Grey



Chrome



Satin



Shootbolt Handles

Shootbolt handles have five colours to choose from. There is also the additional option for locking shootbolts, both internally and externally. These are popular with Non DocQ compliant configurations which do not have any external handles supplied as standard.

D-Handles

The D-Handle and hinges are supplied in Black as standard. White or Grey are also options for:

- White D-Handle & Hinges for White Internal/External
- Grey D-Handle & Hinges for Grey Internal/External

Grey on White, Foil or Special RAL Colour options are only available with Black D-Handle and Hinges.



PAS24 and Part Q approved



PAS24 tested and Part Q* compliant, the Ultimate Evolution features intermediate shootbolt locks, operated by low projection handles. Doors over 2500mm tall require a shootbolt extension.

Traffic doors incorporate a three-point dead latch and hook lock with dedicated strike plates.



APECS 10 Year Guarantee

Go to www.apecs.co.uk to register your 10 year warranty. Registration must be made within 28 days of installation.



Adjustable Jamb



Simplified door squaring and setting

Its' highly innovative fully adjustable jamb means that the Ultimate Evolution is a very 'forgiving' bi-fold to fit.

The easy adjustment system delivers up to 8mm of tolerance, making it far simpler to align the door - even where apertures are out of square.

This dramatically simplifies door squaring and setting which means the Ultimate Evolution can be effectively and efficiently installed.

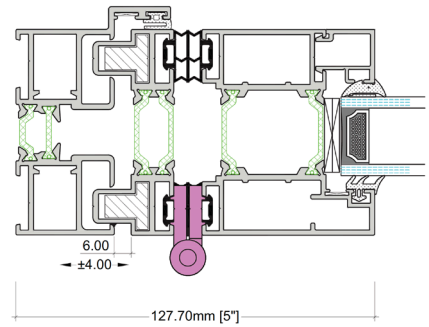

-4 mm

0 mm

+4 mm

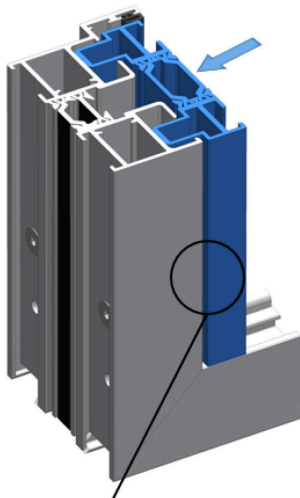

2mm Gap

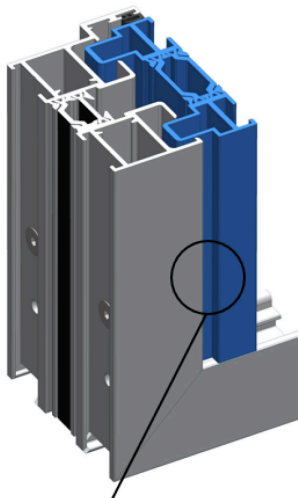

6mm Gap

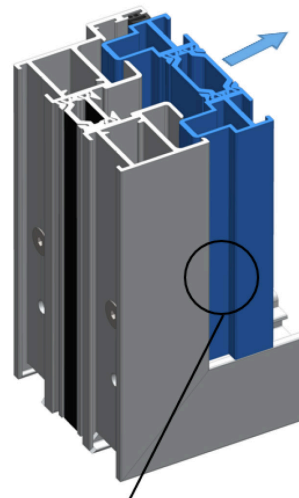

10mm Gap

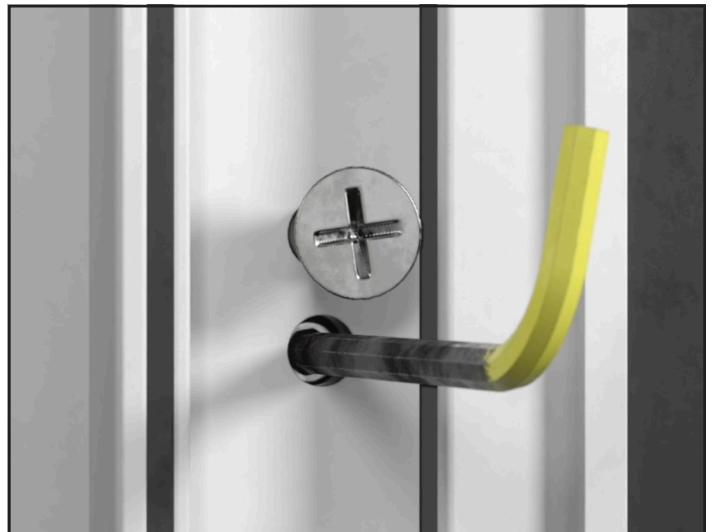

Additional Options



Ventilation Options

An optional 38mm add-on can be applied to the sides or to the head on the frame.

4000mm² vents can be situated within the 38mm add-on, or 3000mm² vents can be positioned within the sashes.

Both vents are available in White, Grey or Black.

Foil and Special RAL orders only have the option for Black vents.

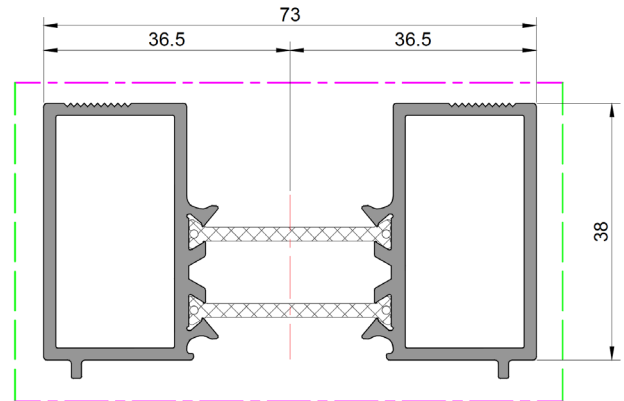

Beading Options

Whether the decision is for double or triple glazed units, the Ultimate Evolution has both 28mm or 35mm beading to accommodate the glass choice.

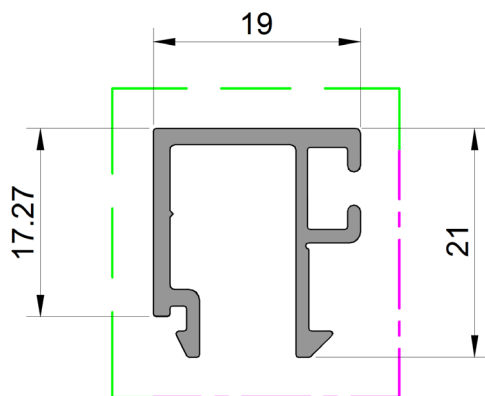

Bead for 28mm Double Glazed

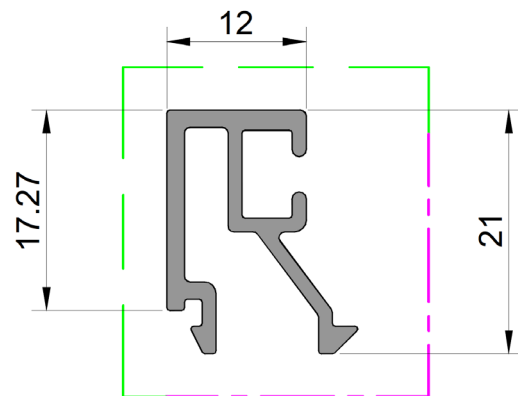

Bead for 35mm Triple Glazed

The Ultimate Evolution



- Slim sightlines and inline system with sash and outer frame the same depth
- External Gasket, evades draft and light penetration remedial issues
- Sash heights from 1800mm - 3000mm
- Sash width from 600mm - 1200mm
- Adjustable Jambs as standard
- Fully assembled from the ground up on rigs
- White, Grey and Grey on White standard colours
- Golden Oak or Rosewood Foil on White
- 400+ RAL colour options
- Ultra-smooth bottom running
- 30mm polyamide thermal break for increased thermal values
- Internally glazed accomodating 28mm and 35mm (triple glazed) IGUs
- U-Values ranging from 1.5Wm²/K to 1.7Wm²/K
- Part Q compliant, including PAS24 and BS6375 Part 1 Weather Testing
- Regimental Quality Control - every bifold tested, filmed and fully packaged
- Installation manual and film guides provided



The Ultimate

EVOLUTION Aluminium Bi-Folding Door



High precision manufacture

We employ the strictest quality management system, going far beyond our BSI approved controls.

This includes the manufacture of doors on rigs, which means that all running and door operation is fully tested before doors leave the factory floor.

Fully wrapped and delivered by our dedicated fleet, it means that we're able to offer you guaranteed quality and service.

Images shown are for illustration purposes only

MAR2021

